

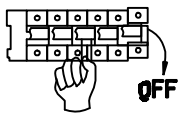

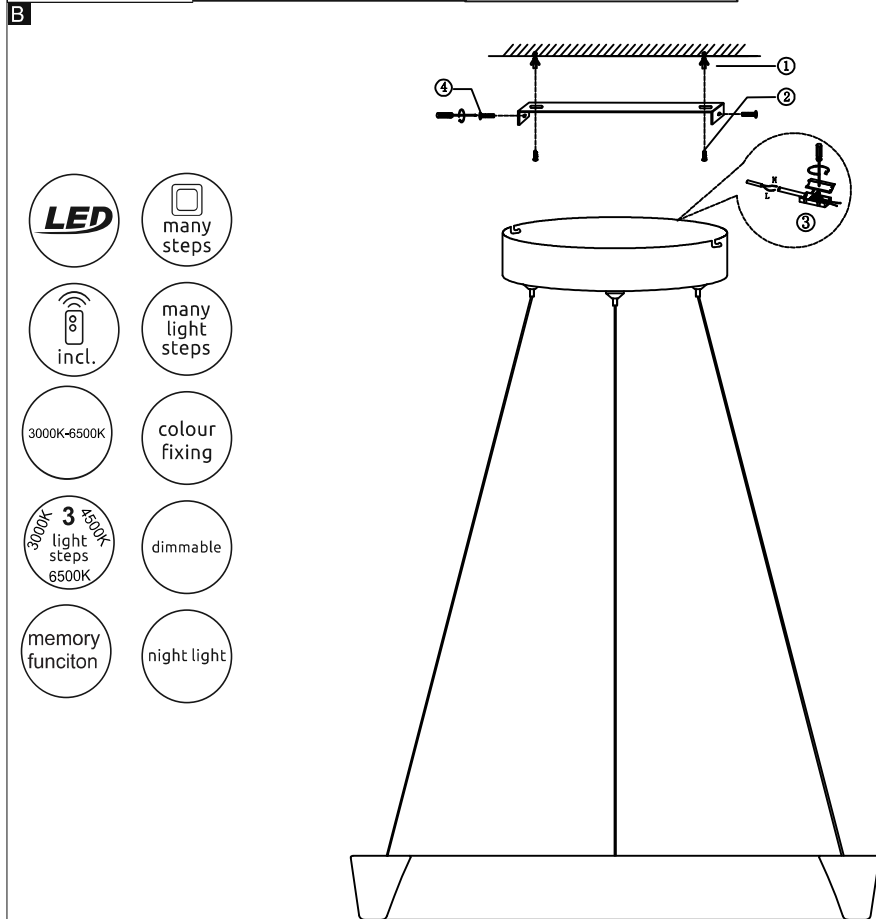







GLOBO

LIGHTING

48272H-36B

	Frequency Bandwidth	Maximal radiation transmitting power
	2400-2483.5MHz	<7dBm



-  LED
-  many steps
-  incl.
-  many light steps
-  3000K-6500K
-  colour fixing
-  3 light steps
3000K 4500K 6500K
-  dimmable
-  memory funciton
-  night light

GLOBO Handels GmbH
 Gewerbestrasse 3
 A-9184 Sankt Peter AUSTRIA
 www.globo-lighting.com

1 x 40W LED 40V
 230V~ 50/60Hz

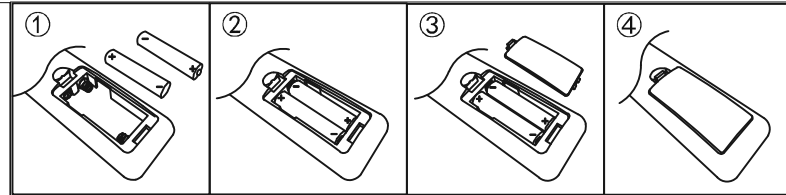

Battery: 2 x AAA 1.5V

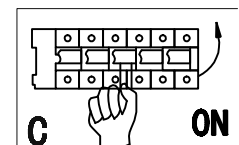
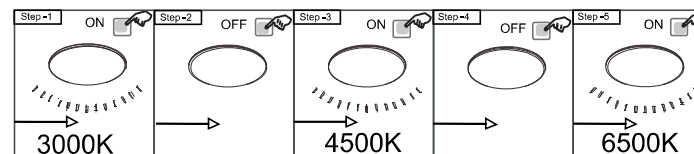
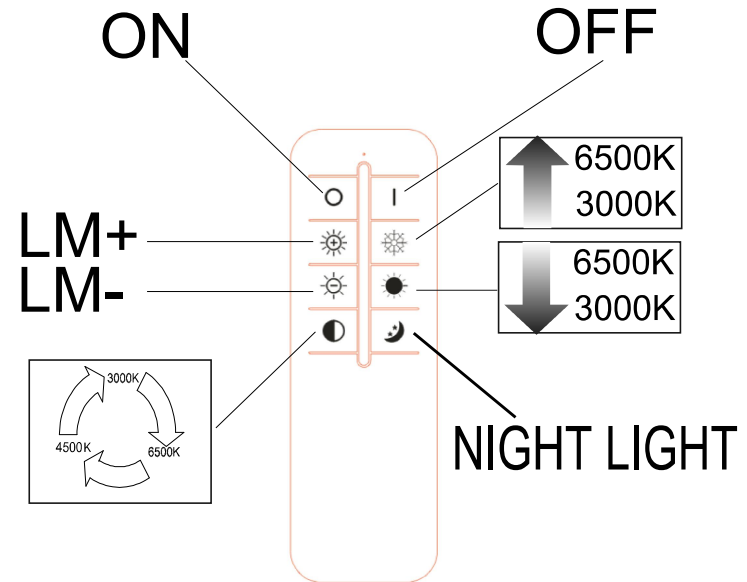

Lichtquelle /Light Source:

DEU:

Lichtquelle:

Die Lichtquelle ist nicht tauschbar, weil sie konstruktionsbedingt fest mit dem umgebenden Produkt verbunden ist.
Dieses Produkt enthält eine Lichtquelle der Energieeffizienzklasse <E>.

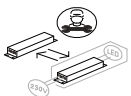

Das Betriebsgerät kann nur durch einen Fachmann ausgetauscht werden.



Die LED - Lichtquelle ist nicht austauschbar.

GBR:

Light source:

The light source is not interchangeable because it is determined by the surrounding product design.
This product contains a light source of energy efficiency class <E>.

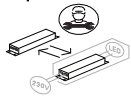

The control gear can be replaced by a professional.



The LED - light source cannot be replaced.

BIH:

Izvor svjetla :

Izvor svjetla nije zamjenjiv , jer je konstrukcijski pričvršćen na proizvod .
Ovaj proizvod sadržava izvor svjetlosti klase energetske učinkovitosti <E>.

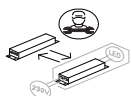

Pogonski uređaj smije zamjeniti samo stručna osoba .



LED – izvor svjetla nije moguće zamjeniti

BG:

Източник на светлина:

Източникът на светлина не може да се подменя, тъй като поради конструкцията си е трайно фиксиран към заобикалящия го продукт.

Този продукт включва светлинен източник с клас на енергийна ефективност <E>.

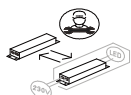

Устройството за управление може да се подменя само от специалист.



LED източникът на светлина не може да се подменя.

CZ:

Zdroj světla:

Světelný zdroj není možné vyměnit, protože je díky své konstrukci pevně spojený s produktem.

Tento výrobek obsahuje světelný zdroj s třídou energetické účinnosti <E>.

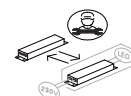

Výměna předřadníku pouze odborníkem

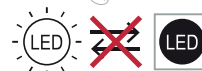

Světelný zdroj není výměnitelný.

DK:

Lyskilde:

Lyskilden kan ikke udskiftes, fordi den er fast forbundet med det omgivende produkt.

Dette produkt indeholder en lyskilde i energieffektivitetsklasse <E>.

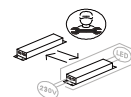

Driftsenheden kan kun skiftes af en fagperson.



LED- lyskilden kan ikke udskiftes.

ET:

Valgusallikas:

Valgusallikas ei ole välja vahetatav, sest ta on tootega ehituslikult kindlalt seotud.

Toode sisaldab energiatõhususe klassi <E> valgusallikat.

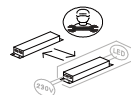

Juhtseadmed võib asendada professionaalne.



LED - valgusallikat ei saa asendada.

FI:

Valonlähde:

Valonlähdettä ei voi vaihtaa uuteen, sillä se on rakenteellisesti yhdistetty ympäröivään tuotteeseen.

Tämä tuote sisältää valonlähteen, jonka energiatehokkuusluokka on <E>.

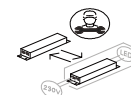

Vain ammattihenkilö voi vaihtaa liitäntälaitteen.



LED-valonlähdettä ei voi vaihtaa uuteen.

FR:

Source lumineuse:

La source lumineuse n'est pas remplaçable car elle est, de par la construction du produit, liée de façon permanente à celui-ci.
Ce produit contient une source lumineuse de classe d'efficacité énergétique <E>.

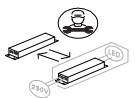

L'unité de contrôle ne peut être remplacée que par un



La source lumineuse LED n'est pas remplaçable.

GR:

Φωτεινή πηγή:

Η φωτεινή πηγή δεν μπορεί να αντικατασταθεί, επειδή είναι για κατασκευαστικούς λόγους σταθερά συνδεδεμένη με το προϊόν που την περιβάλλει.
Το προϊόν αυτό περιέχει φωτεινή πηγή της τάξης ενεργειακής απόδοσης <E>.

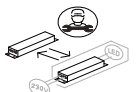

Η λειτουργική συσκευή μπορεί να αντικατασταθεί μόνο από έναν ειδικό.



Η φωτεινή πηγή LED δεν αντικαθίσταται.

HU:

Fényforrás:

A fényforrás nem cserélhető, mert felépítése miatt szilárdan csatlakozik a termékhez.
Ez a termék egy <E> energiahatékonysági osztályú fényforrást tartalmaz.



Az előtétet csak szakértők cserélhetik ki.



A fényforrás nem cserélhető

Isländisch/IS:

Ljósgrjafi:

Ljósgrjafinn er ekki útskiptanlegur vegna þess að hann er háður umliggjandi hönnun vörunnar.
Varan inniheldur ljósgrjafa í orkuflokki <E>.

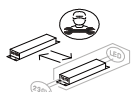

Aðeins fagmenn mega skipta um stjórnbúnaðinn..



EKKI er hægt að skipta um LED-ljósgrjafann.

IT:

Sorgente luminosa:

La sorgente luminosa non è intercambiabile perché è saldamente collegata al prodotto per via del suo design.
Questo prodotto contiene una sorgente luminosa di classe di efficienza energetica <E>.

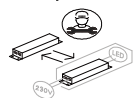

L'alimentatore può essere sostituito solo da personale specializzato.



La sorgente luminosa a LED non può essere sostituita.

HR :

Izvor svjetla :

Izvor svjetla nije zamjenjiv , jer je konstrukcijski pričvršćen na proizvod .
Ovaj proizvod sadržava izvor svjetlosti klase energetske učinkovitosti <E>.

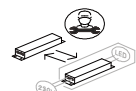

Pogonski uređaj smije zamjeniti samo stručna osoba .



LED – izvor svjetla nije moguće zamjeniti

LV:

Gaismas avots:

Gaismas avotu nevar nomainīt, jo tas konstrukcijā ir cieši savienots ar izstrādājuma apkārtējo daļu.
Šis ražojums satur gaismas avotu, kura energoefektivitātes klase ir <E>.

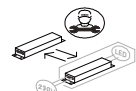

Vadības ierīci var nomainīt speciālists.



LED apgaismes līdzekļi nevar nomainīt.

LT:

Šviesos šaltinis:

Šis šviesos šaltinis yra nekeičiamas, nes jis prijungtas prie gaminio pagal jo konstrukciją.
Šiame gaminyje yra šviesos šaltinis, kurio energijos vartojimo efektyvumo klasė <E>.

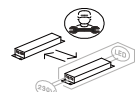

Valdymo įtaisą gali pakeisti tik tam kvalifikuotas specialistas.



LED šviesos šaltinis yra nekeičiamas.

NL:
Lichtbron:
De lichtbron kan niet worden vervangen, omdat deze vanwege de constructie vast met het product eromheen verbonden is.
Dit product bevat een lichtbron van energie-efficiëntieklasse <E>.

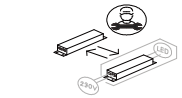

Het apparaat kan alleen door een vakman worden vervangen.



De LED-lichtbron kan niet worden vervangen.

Norwegisch/Norwegian / NO:
Lyskilde:

Lyskilden kan ikke byttes fordi den sitter fast i Produktet.
Dette produktet inneholder en lyskilde i energiklasse <E>.

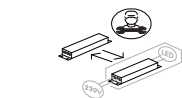

Driverenheten kan kun byttes av fagmann.



LED-lyspæren kan ikke byttes.

PL:
Źródło światła:

Źródła światła nie można wymienić, ponieważ jest zintegrowane z produktem ze względu na swoją konstrukcję.
Ten produkt zawiera źródło światła o klasie efektywności energetycznej <E>.

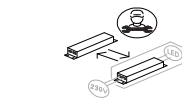

Urządzenie sterujące może zostać wymienione przez



LED - źródło światła nie może być wymienione.

PT:
Fonte de Luz:

A fonte de luz não é substituível porque devido às suas características construtivas está fixada de forma permanente ao produto circundante.
Este produto contém uma fonte de luz da classe de eficiência energética <E>.

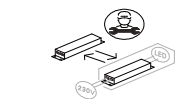

Substituição do equipamento de controlo por um profissional.



Lâmpada não substituível.

RO:
Sursa de lumina:
Sursa de lumina nu este inlocuibilă ea fiind parte constructivă a produsului.
Acest produs conține o sursă de lumină cu clasa de eficiență energetică <E>.

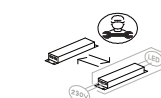

Driverul poate fi înlocuit doar de către personal specializat



Sursa de lumina nu poate fi înlocuită

RUS:
Источник света:
Источник света не является взаимозаменяемым, поскольку это определяется конструкцией смежного продукта.
Данный продукт содержит источник света класса энергоэффективности <E>.



Устройство управления может заменяться только квалифицированным специалистом.



Светодиодный источник света не подлежит замене.

SRB:
Izvor svetlosti:
Izvor svetlosti nije zamenljiv, jer je zbog svog dizajna čvrsto povezan sa proizvodom koji ga opkružuje.
Ovaj proizvod sadrži izvor svetlosti klase energetske efikasnosti <E>.

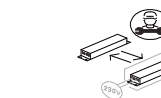

квалифицированным специалистом.



LED izvor svetlosti nije zamenljiv.

SK:
Zdroj svetla:
Svetelný zdroj nie je možné vymeniť, pretože je vďaka svojej konštrukcii pevne spojený s produktom.
Tento výrobok obsahuje svetelný zdroj triedy energetickej účinnosti <E>.

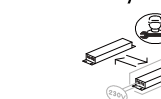

Výmena predradníka len odborníkom.



Svetelný zdroj nie je vymeniteľný.

SI:

Izvor svetlobe:

Vir svetlobe ni zamenljiv, ker je določen z zasnovo izdelka v okolici.
Ta izdelek vsebuje svetlobni vir razreda energijske učinkovitosti <F>.

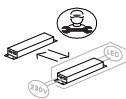

Krmilno napravo lahko zamenja samo strokovno usposobljena oseba



Svetlobni vir ni mogoče zamenjati.

ES:

Fuente de luz:

La fuente de luz no es sustituible porque está fija en el producto desde la construcción.
Este producto contiene una fuente luminosa de la clase de eficiencia energética <F>.

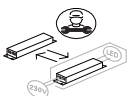

Sustitución del aparato por un profesional.



Bombilla no reemplazable.

SE:

Ljuskälla:

Ljuskällan är inte utbytbar, eftersom den på grund av konstruktionen är fast integrerad i den omgivande produkten.
Denna produkt innehåller en ljuskälla med energieffektivitetsklass <F>.

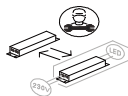

Driftdonet kan endast bytas ut av en fackman.



LED-ljuskällan kan inte bytas ut.

TR:

Işık kaynağı:

Konstrüksiyon gereği çevreleyen ürün ile sabit bir şekilde bağlı olduğu için ışık kaynağı değiştirilemez.

Bu ürün, <F> enerji sınıfından bir ışık kaynağına sahiptir.

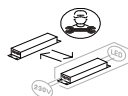

İşletme cihazı sadece bir uzman tarafından değiştirilebilir.



LED ışık kaynağı değiştirilemez.

UK:

Джерело світла:

Джерело світла не можна обміняти, оскільки воно міцно пов'язане з навколишнім виробом завдяки своїй конструкції.
Цей виріб містить джерело світла класу енергоефективності <F>.

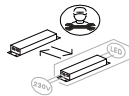

– лише фахівець може замінювати пристрій керування.



– джерело світлодіодного світла не можна замінювати.